

2386	Çevre (mm) Perimeter	207,5
	Alan (mm ²) Area	262,1
	Ağırlık (gr/m) Weight	713

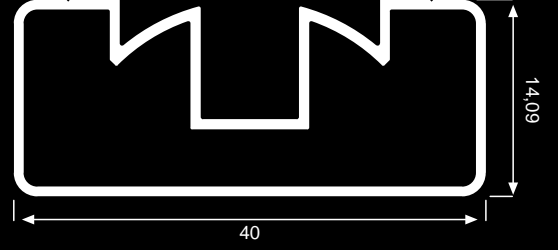

2387	Çevre (mm) Perimeter	53
	Alan (mm ²) Area	59
	Ağırlık (gr/m) Weight	160

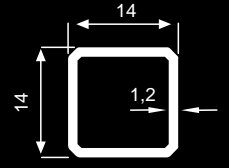

2388	Çevre (mm) Perimeter	219,6
	Alan (mm ²) Area	216,1
	Ağırlık (gr/m) Weight	585

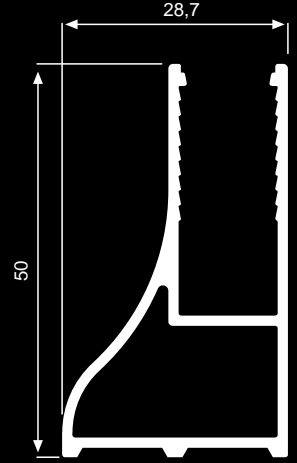

2389	Çevre (mm) Perimeter	178,7
	Alan (mm ²) Area	277,8
	Ağırlık (gr/m) Weight	753

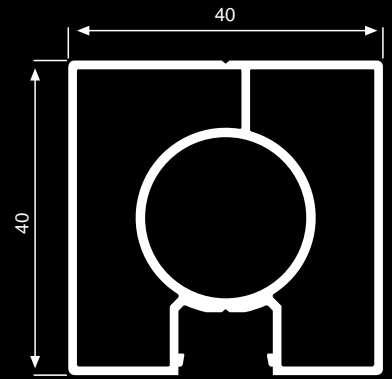

2390	Çevre (mm) Perimeter	120,4
	Alan (mm ²) Area	94
	Ağırlık (gr/m) Weight	254

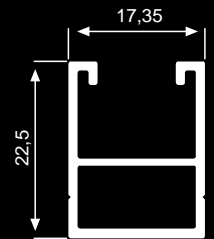

2391

Çevre (mm) Perimeter	214,3
Alan (mm ²) Area	237,6
Ağırlık (gr/m) Weight	643

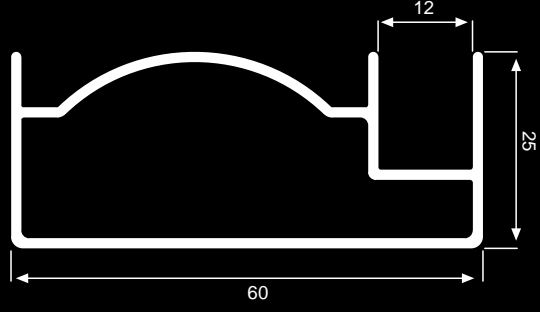

2392

Çevre (mm) Perimeter	308
Alan (mm ²) Area	337,8
Ağırlık (gr/m) Weight	915

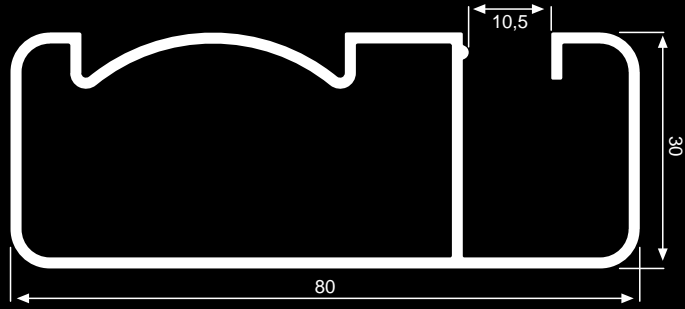

2393

Çevre (mm) Perimeter	265,6
Alan (mm ²) Area	271,9
Ağırlık (gr/m) Weight	737

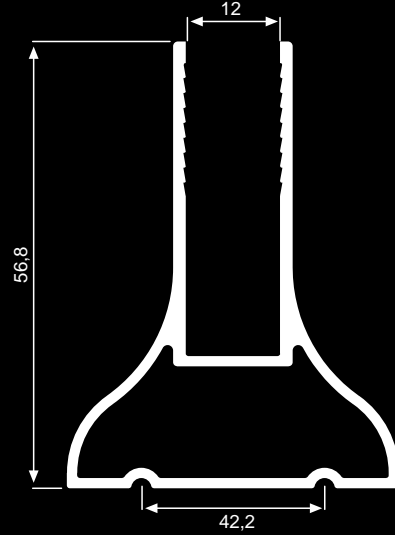

2394

Çevre (mm) Perimeter	38,7
Alan (mm ²) Area	17,2
Ağırlık (gr/m) Weight	46

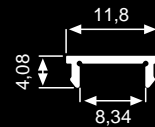

2414

Çevre (mm) Perimeter	57,1
Alan (mm ²) Area	32,1
Ağırlık (gr/m) Weight	87

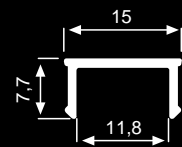

2415	Çevre (mm) Perimeter	240,1
	Alan (mm ²) Area	193,1
	Ağırlık (gr/m) Weight	523

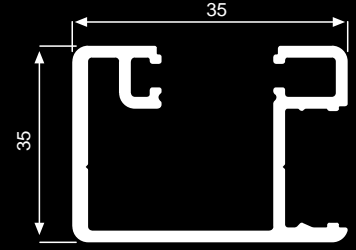

2416	Çevre (mm) Perimeter	254,5
	Alan (mm ²) Area	370,8
	Ağırlık (gr/m) Weight	1004

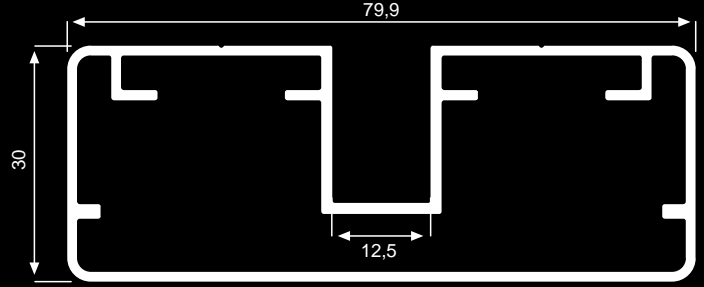

2441	Çevre (mm) Perimeter	179,3
	Alan (mm ²) Area	211
	Ağırlık (gr/m) Weight	572

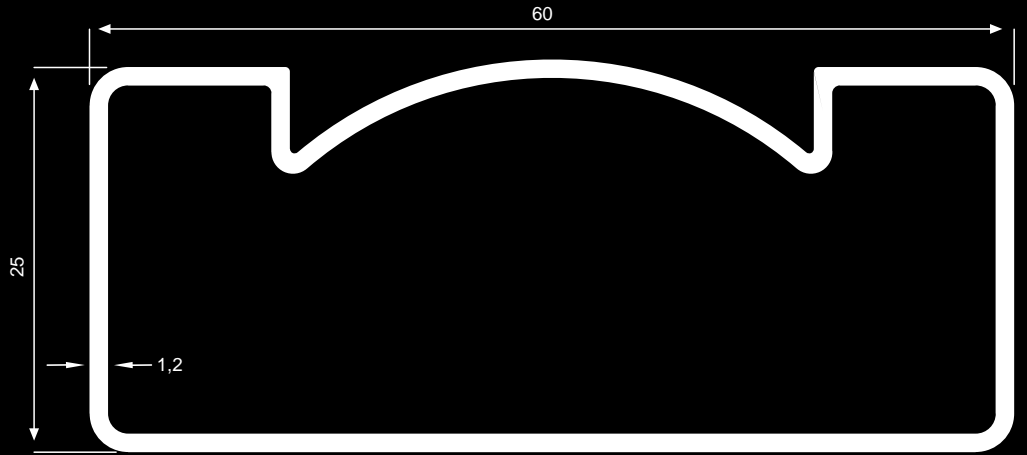

2457	Çevre (mm) Perimeter	181
	Alan (mm ²) Area	282,2
	Ağırlık (gr/m) Weight	764

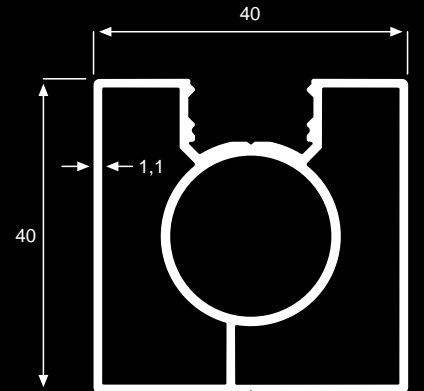

2048	Çevre (mm) Perimeter	50.3
	Alan (mm ²) Area	47.1
	Ağırlık (gr/m) Weight	128

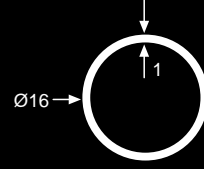

2047	Çevre (mm) Perimeter	110
	Alan (mm ²) Area	187.7
	Ağırlık (gr/m) Weight	509

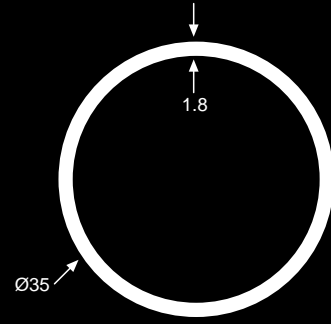

2440	Çevre (mm) Perimeter	110
	Alan (mm ²) Area	157,9
	Ağırlık (gr/m) Weight	428

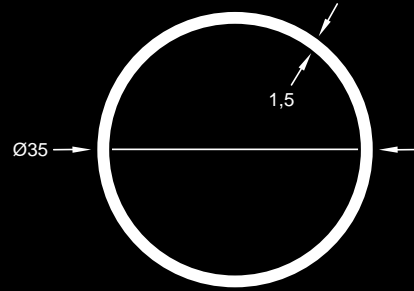

2046	Çevre (mm) Perimeter	157
	Alan (mm ²) Area	176.5
	Ağırlık (gr/m) Weight	478

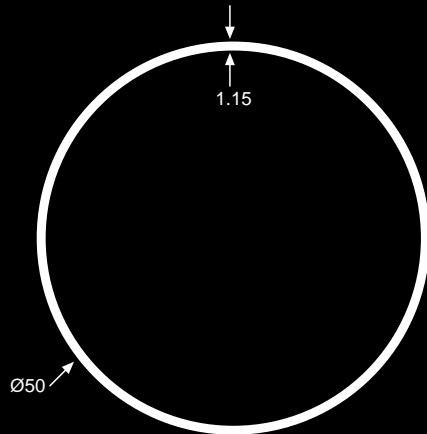

2396

Çevre (mm) Perimeter	157,1
Alan (mm ²) Area	206,3
Ağırlık (gr/m) Weight	559

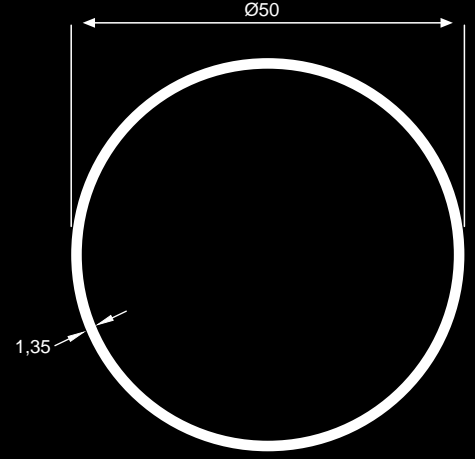

2438

Çevre (mm) Perimeter	157,1
Alan (mm ²) Area	228,6
Ağırlık (gr/m) Weight	620

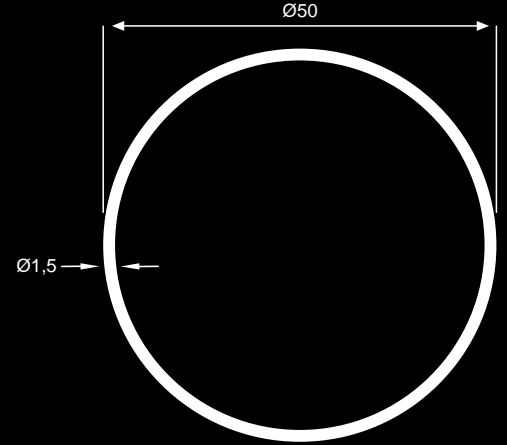

2408

Çevre (mm) Perimeter	157,1
Alan (mm ²) Area	272,6
Ağırlık (gr/m) Weight	738

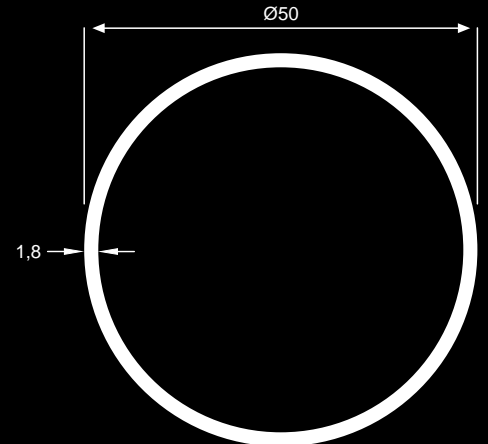

2398	Çevre (mm) Perimeter	49,5
	Alan (mm ²) Area	25,5
	Ağırlık (gr/m) Weight	69

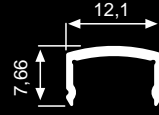

2397	Çevre (mm) Perimeter	140,2
	Alan (mm ²) Area	297,1
	Ağırlık (gr/m) Weight	805

